

DESCRIPTION

CM1 series Indicator has been designed in simple function and 4 digital 20.0mm LED displays with economic cost. They are also can be programmed by tack switches that are hidden in backside of front bezel.

FEATURE

- Measuring AC / DC Voltage 0~600V / Current 0~10A
- Optional output available for one of 2 relay, analogue or RS485
- CE Approved & RoHS

APPLICATIONS

- Testing Equipments for Volt/Current Measuring,
- MCC panel, Machinery, Switch gear... for Voltage or Current Measuring



ORDERING INFORMATION

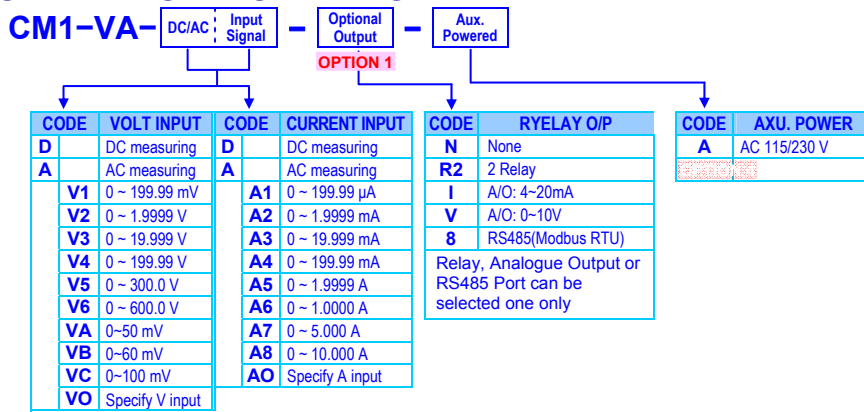

TECHNICAL SPECIFICATION

Input Range		Measuring Range DC / AC	Input Impedance	Measuring Range DC / AC	Input Impedance
Voltage	0~50~100	≥5M ohm	Current	0~199.99μA	1K ohm
	0~199.99 mV	≥5M ohm		0~1.9999 mA	100 ohm
	0~1.9999 V	≥1M ohm		0~19.999 mA	10 ohm
	0~19.999 V	≥1M ohm		0~199.99 mA	1 ohm
	0~199.99 V	≥1M ohm		0~1.9999 A	0.05 ohm
	0~300.0 V	≥2M ohm		0~5.000 A	0.02 ohm
Voltage	0~600.0 V	≥2M ohm	0~10.000 A	0.01 ohm	

Calibration: Digital calibration by front key
A/D converter: 12 bits resolution
Accuracy: DC: ≤± 0.1% of FS ± 1C
 AC: ≤± 0.2% of FS ± 1C
Sampling rate: 15 cycles/sec
Response time: ≤ 100 msec.(when the AvG = "1") in standard

Display & Functions
LED: Numeric: 4 digits, 0.8"(20.0mm) red high-brightness LED
Display range: -1999~+9999
Scaling function: L₀S_C: Low Scale; Settable range: -1999~+9999
 H₀S_C: High Scale; Settable range: -1999~+9999
Decimal point: Programmable from 0 / 00 / 000 / 0000
Over range Indication: o₀FL, when input is over 110% of input range Hi
Under range indication: -o₀FL, when input is under -0% of input range Lo
Max / Mini recording: Maximum and Minimum value storage during power on.
Low cut: L₀U_t: Settable range: -1999~9999 counts

Reading Stable Function
Average: R₀G Settable range: 1~99 times
Moving average: nR₀G Settable range: 1(None)~99 times
Digital filter: dF₀L_t Settable range: 0(None)/1~99 times

Control Functions(option)

Set-points: Two set-point
Control relay: 2 Relay, FORM-C, 5A/230Vac, 10A/115V
Relay energized mode: Energized levels compare with set-points:
 Hi / Lo / Hi.HLd / Lo.HLd programmable
Energizing functions: Start delay / Energized & De-energized delay / Hysteresis Energized Latch
Start band(Minimum level for Energizing): 0~9999counts
Start delay time: 0:00.0~9(Minutes):59.9(Second)
Energized delay time: 0:00.0~9(Minutes):59.9(Second)
De-energized delay time: 0:00.0~9(Minutes):59.9(Second)
Hysteresis: 0~5000 counts

Analogue output(option)

Accuracy: ≤± 0.2% of F.S.
Ripple: ≤± 0.1% of F.S.
Response time: ≤100 msec. (10~90% of input)
Isolation: AC 2.0 KV between input and output
Output range: Specify either Voltage or Current output in ordering
Voltage: 0~5V / 0~10V / 1~5V programmable
Current: 0~10mA / 0~20mA / 4~20mA programmable
Output capability: Voltage: 0~10V; ≥ 1000Ω;
 Current: 4(0)~20mA; ≤ 600Ω max
Functions: R₀H₅ (output range high): Settable range: -1999~9999
 R₀L₅ (output range Low): Settable range: -1999~9999
Digital fine adjust: R₀P₀: Settable range: -38011~+27524
 R₀S_Pn: Settable range: -38011~+27524

RS 485 Communication(option)

Protocol: Modbus RTU mode
Baud rate: 1200/2400/4800/9600/19200/38400 programmable
Data bits: 8 bits
Parity: Even, odd or none (with 1 or 2 stop bit) programmable
Address: 1 ~ 255 programmable
Distance: 1200M
Terminate resistor: 150Ω at last unit.

Electrical Safety

Dielectric strength: AC 2.0 KV for 1 min, Between Power / Input / Output / Case
Insulation resistance: ≥100M ohm at 500Vdc, Between Power / Input / Output
Isolation: Between Power / Input / Relay, Analogue or RS485
EMC: EN 55011:2002; EN 61326:2003
Safety(LVD): EN 61010-1:2001

Environmental

Operating temp.: 0~60 °C
Operating humidity: 20~95 %RH, Non-condensing
Temp. coefficient: ≤100 PPM/°C
Storage temp.: -10~70 °C
Enclosure: Front panel: IEC 549 (IP54); Housing: IP20

Mechanical

Dimensions: 96mm(W) x 48mm(H) x 72mm(D)
Panel cutout: 92mm(W) x 44mm(H)
Case materiel: ABS fire-resistance (UL 94V-0)
Mounting: Panel flush mounting
Terminal block: Plastic NYLON 66 (UL 94V-0)
 20A/600Vac, M3.5, 12~22AWG
Weight: 350g

■ DIMENSIONS

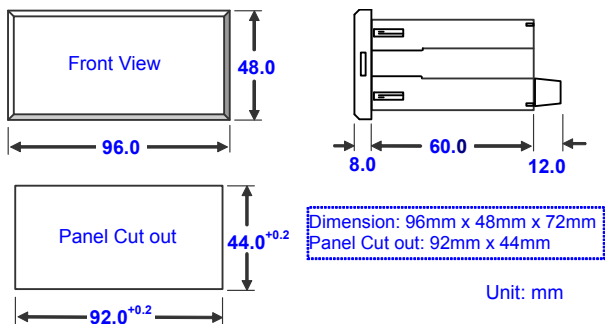

■ INSTALLATION

The meter should be installed in a location that dose not exceed the maximum operating temperature and provides good air circulation.

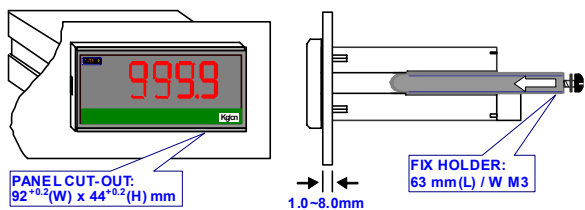

■ CONNECTION DIAGRAM

Terminal blocks:
 20A/600Vac, M3.5, 1.2~3.5mm² (22~12AWG)

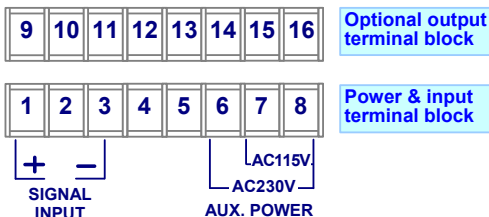

Power and Input

Please check the voltage of power supplied first, and then connect to the specified terminals. It is recommended that power supplied to the meter be protected by a fuse or circuit breaker.

Power Supply

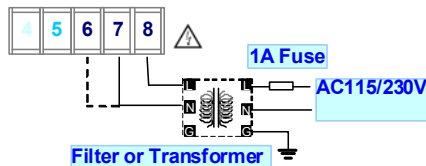

CM1-VA Input connection

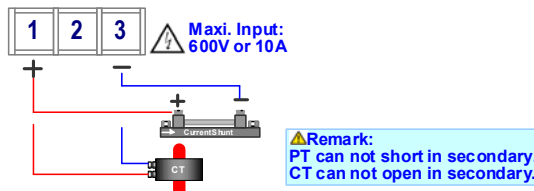

Output (one output available of Relay, Analogue or RS485)

Relay output



Analogue output

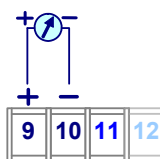

RS485 port

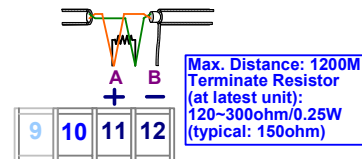

■ FUNCTION DESCRIPTION

Scaling function:

Setting the [L_oSC] (Low scale) and [H_oSC] (High scale) in [mPUT GROUP] to relative input signal. Reverse scaling will be done too. Please refer to the figure as below,

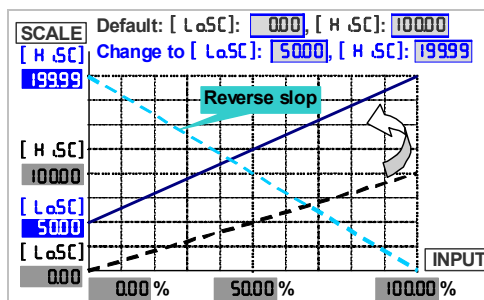

*Too narrow scale may course display lower resolution.

OPERATING KEY

*Please access to the Programming Level to check and set the parameters when users start to run the meter

- **Operating Key:** 4 keys for Enter(Function) / Shift(Escape) / Up key / Down key
- The meter has designed operation similar as PC's and . In any page, press key means "enter" or "confirm setting", and press key means "escape()" or "shift".
- In Programming Level, the screen will return to Measuring Page after do not press any key over 2 minutes, or press for 1 second.

	Function Index	Setting Status
(= Enter/Fun key	(1) In any page, press to access the level or function index (2) From the function index to access setting status	(3) Setting Confirmed, save to EEPROM and go to next function index
(= Shift key	(1) In measuring page, press for 1 second to access user level. (2) In function index, press for 1 second to go back upper level. (3) In function group index, press for 1 second to go back measuring page	(4) In setting status, press to Shift the setting position. (5) In setting status, press for 1 second to abort setting and go back this function index.
(= Up key	(1) In function index, press to go back to previous function index	(2) In setting status for function, press to select function (3) During number Setting, press can roll the digit up
(= Down key	(1) In Function Index Page, press will go to the next Function Index Page.	(2) In setting status for function, press to select function (3) During number Setting, press can roll the digit down.

FRONT PANEL

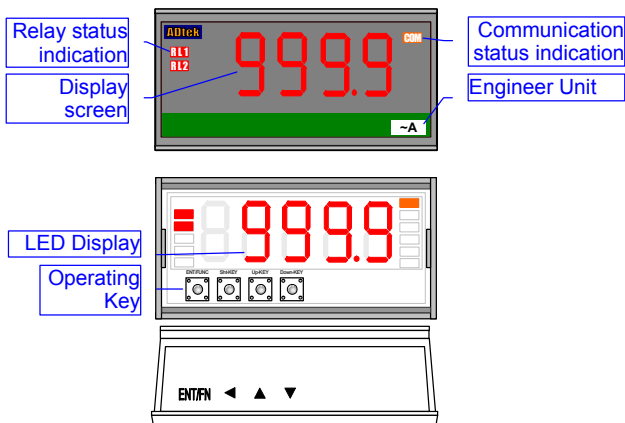

Number screen

0.8"(20.0mm) red high-brightness LED for 5 digital present value.

I/O Status Indication

- **Relay Energized:** 2 square red LED
 display when Relay 1 energized;
 display when Relay 2 energized;
- **RS485 Communication:** 1 square orange LED
 will flash when the meter is receive or send data, and flash quickly means the data transient quicker.

Stickers:

Each meter has a sticker for engineer units.

~μA	~mA	~A	~KA	=μA	=mA	=A	=KA		
~μV	~mV	~V	~KV	=μV	=mV	=V	=KV		
A hr	A min	A sec	A rms	V rms	A/mA	W/A	Var/A		
W	KW	MW	WH	KWH	MWH	W/WH	W/Var		
Var	KVar	MVar	QH	KQH	MQH	COSφ	Var/VarH		
VA	KVA	MVA	VAH	KVAH	MVAH	φ	KVarH		
Hz	PF	KA	KV	KHz	MVarH	KM/hr			
A	mA	V	mV	Ω	KΩ	°C	°F	%RH	
RPM	M/min	Y/min	F/min	M/sec	%		MΩ		
Kg/cm ²	Bar	mmH ₂ O	mmHg	KPA	mmAq	PSI	mBar	PA	
M ³ /min	ml/min	Ton/D	L/min	Torr	M ³ /hr	Kg-cm	cmHg		
mm	cm	M	KM	ft	Yard	ppm	ppb		
g	KG	Ton	T-cm	NT-cm	PH	MPM	L		

- **Operating Key:** 4 keys for Enter(Function) / Shift(Escape) / Up key / Down key

- **Pass Word:** Settable range:0000~9999;

User has to key in the right pass word so that get into [Programming level]. Otherwise, the meter will go back to measuring page. If user forgets the password, please contact with the service window.

OPERATING DIAGRAM (The detail description of operation, please refer to operating manual.)

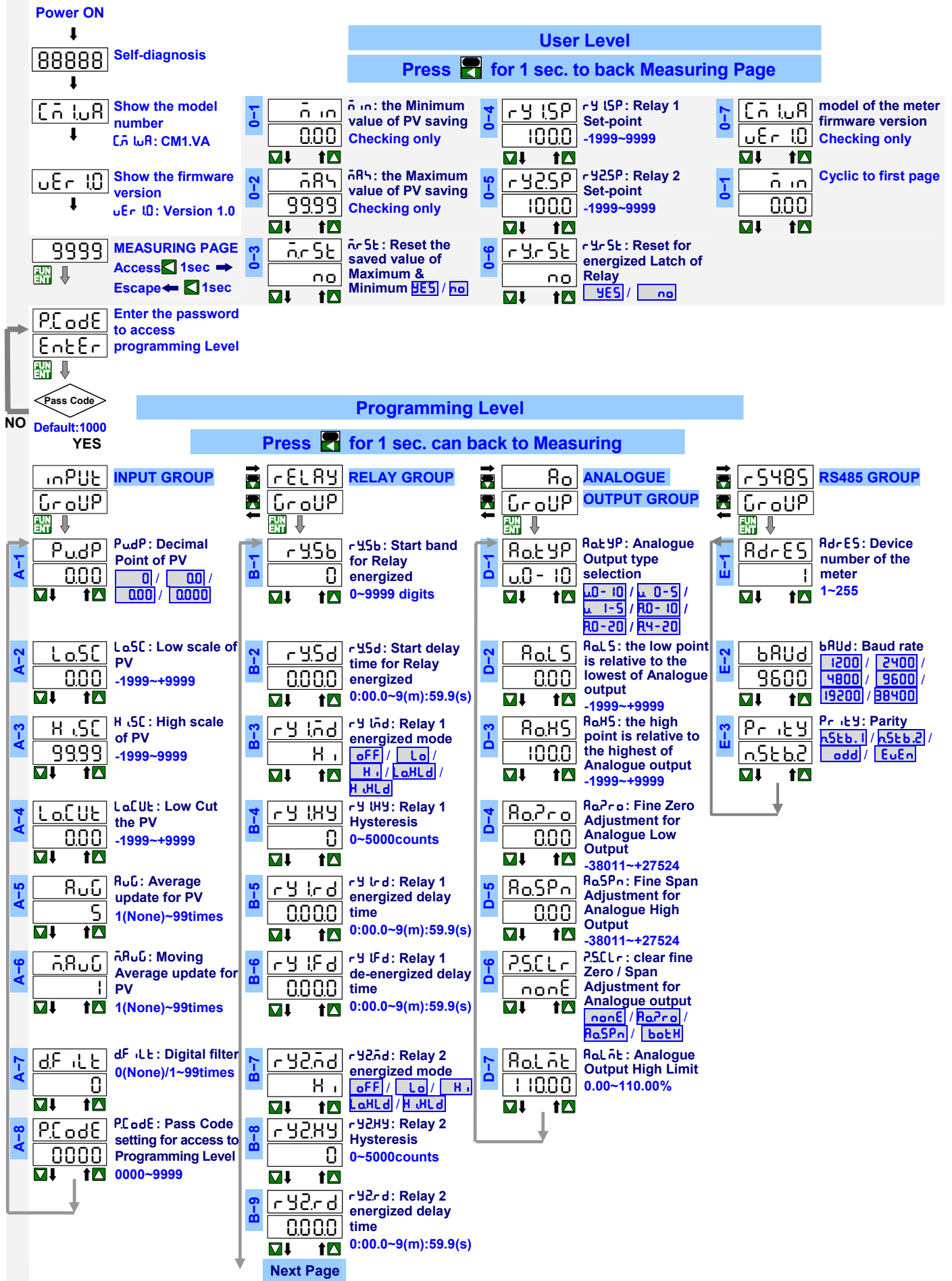

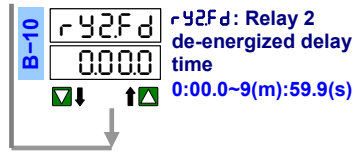

Please refer to operating manual for detail description